

So You Want to Know Connectors

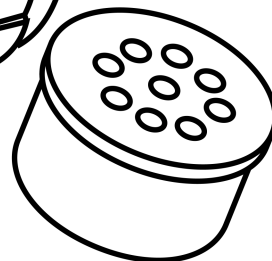
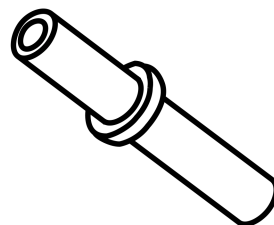
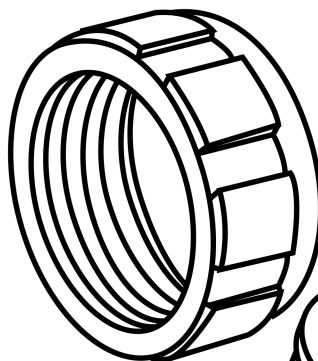
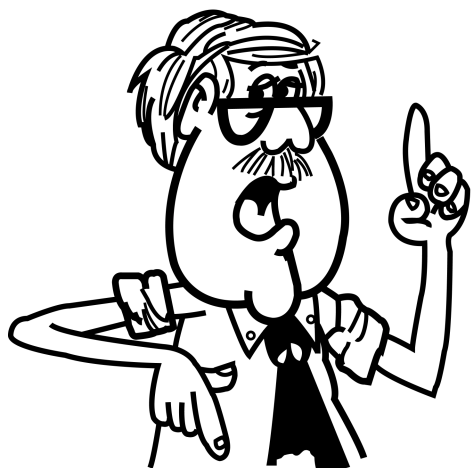
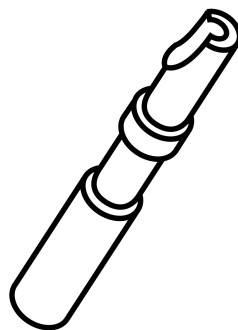
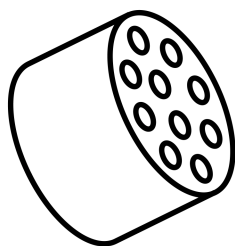
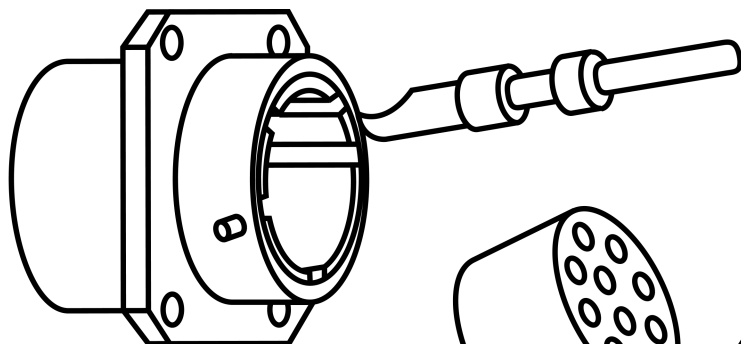

A REFERENCE GUIDE to Cylindrical Connectors

Amphenol

This booklet is intended to be used as a ready reference to typical standard, miniature and subminiature cylindrical connector part numbers and terminology. Reading its brief pages will not make you a connector expert, but should guide you in becoming familiar with the product, in order to better serve our customers.

Note: Many of the connector products in this brochure were formerly known as "Bendix" products. These products are now manufactured and sold under the Amphenol® brand name. The name "Amphenol" will replace the name "Bendix" on products and literature in the future.

Amphenol Aerospace is a Certified ISO 9001 Manufacturer.

Contents

SECTION I	
Nomenclature: Cylindrical Connectors	2-4
Basic Components	
Know the Language	
SECTION II	
Major MIL-Specifications by Type	
Standard, MIL-C-5015	
Amphenol 97 Series	
Heavy Duty, MIL-C-22992	
Proprietary Variations	5-6
MIL-C-5015 and 97 Series Part Number Breakdown	
MIL-C-22992 Part Number Breakdown	
SECTION III	
Major MIL-Specifications by Type	
Miniature, MIL-C-26482	7-11
MIL-C-26482 Part Number Breakdown	
Miniature Crimp, Solder Part Number Breakdown	
SECTION IV	
Major MIL-Specifications by Type	
Subminiature, MIL-C-38999, MIL-C-27599.....	12-21
Subminiature – JT/LJT, Tri-Start, SJT Features	
JT/LJT Part Number Breakdown and Specifications	
LJT-R/JT-R and Accessories Cross Reference List	
Tri-Start Series III Part Number Breakdown and Specifications	
SJT Part Number Breakdown	
SECTION V	
Cross Reference Data	22

SECTION I

Nomenclature: Cylindrical Connectors

Basic Components

1. Shell (Houses Inserts & Contacts)
2. Insert (Dielectric Contact Insulator) Pin or Socket
3. Contact (Wire End Termination) (Electrical Engagement)
4. Coupling Nut
5. Accessories (Wire Seals, Cable Seals, Wire Support, etc.)

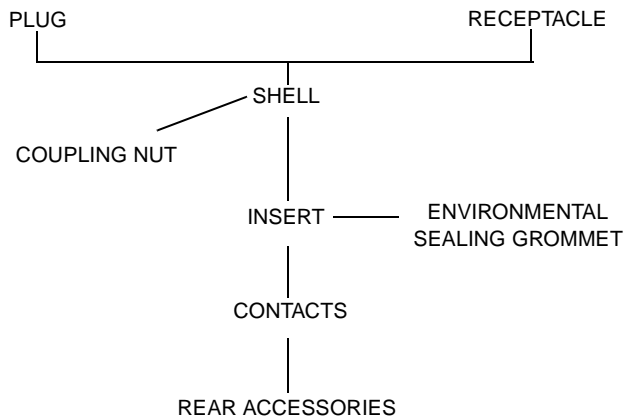

Mated Pair

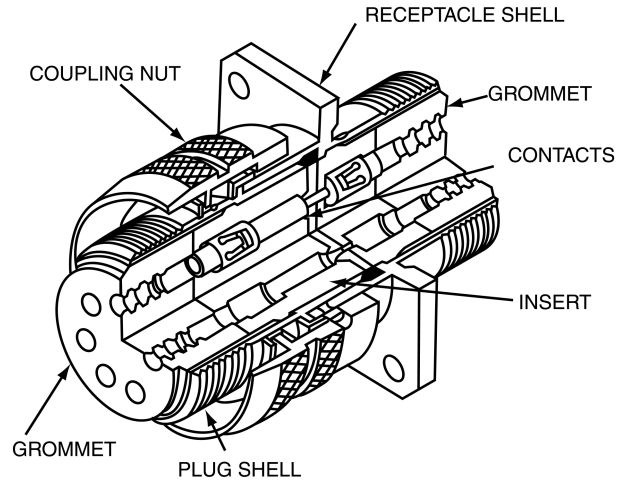

Rear Accessory

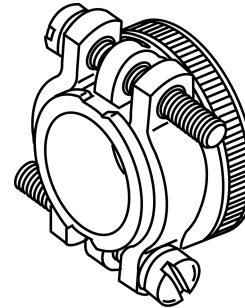

Shell Styles

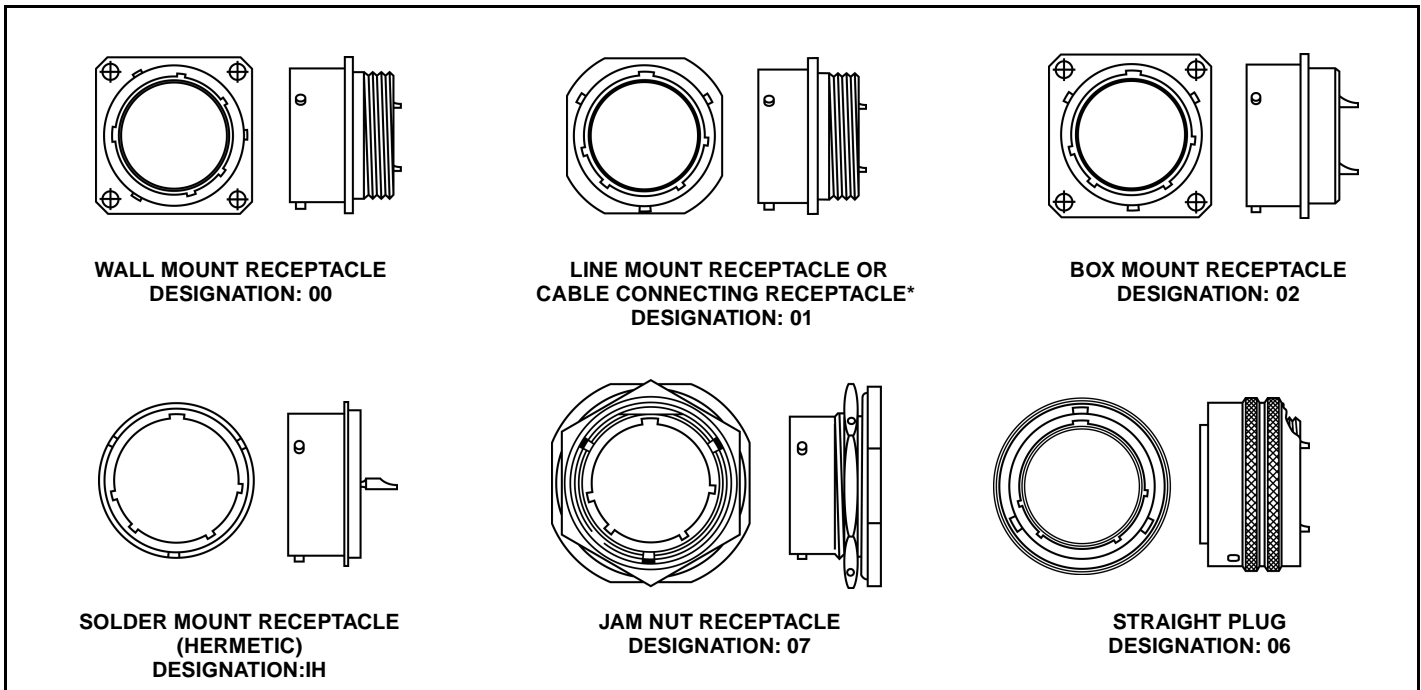

* This connector style is sometimes referred to as a cable connecting "plug." It does, however, mate with either a straight or 90 degree plug.

Shell Styles (Cont'd.)

Coupling

Threaded, Bayonet

Shell Sizes (Typical MIL-C-5015)

8S, 10S, 10SL, 12S, 12,
14S, 14, 16S, 16, 18
20, 22, 24, 28, 32, 36, 40, 44, 48

"S" designates short shell and short contacts

Shell size denotes mating thread diameter in 16ths of an inch. For example, a size 8 shell denotes 8/16 of an inch with a .5000-28 UNEF thread.

Style Designation

PLUG	SHELL STYLES
06	Straight
08	Angle
09	Flange Mount Receptacle
05	Straight, Less Rear Accessory

RECEPTACLE	SHELL STYLES
00	Wall Mount
01	Cable Connecting or Line Mount Receptacle
02	Box Mount
03	Wall Mount, Less Rear Accessory
04	Line Mount, Less Rear Accessory
07	Jam Nut
IH	Solder Mount Hermetic

Inserts

**Insert
(Pin or Socket)**

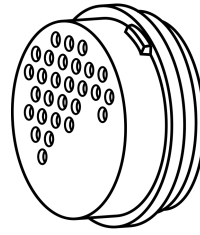

**Insert &
Grommet Assy.**

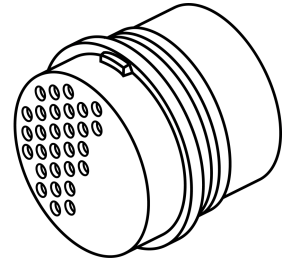

- Solder
- Crimp
- Metal Clip Retention
- Dielectric Retention

May include a soft front interfacial seal (Bonded) if dielectric is hard, and a rear sealing grommet separate or attached.

Contact and Contact Termination Style

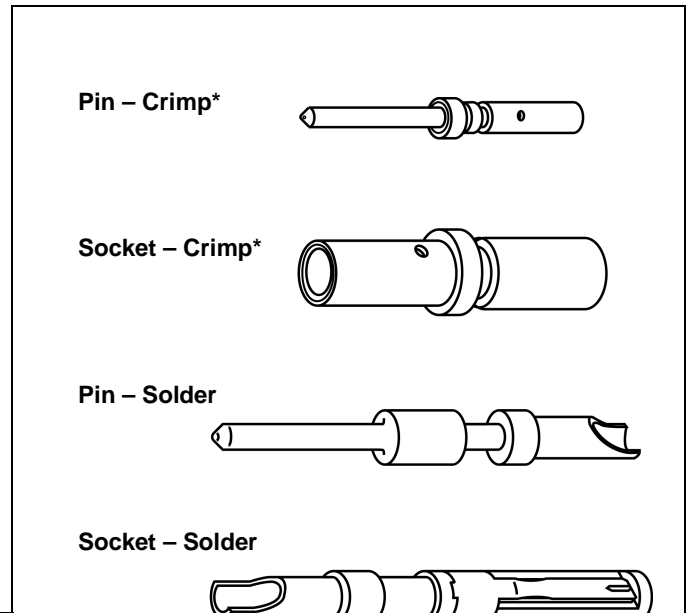

*Crimp is removable

Sizes by Wire Gauge, Examples:

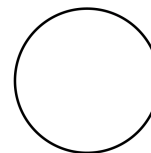
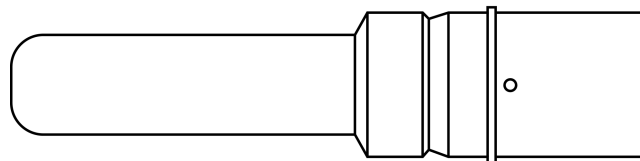

4/0 American Wire Gauge 4/0



22D American Wire Gauge 22-28

Contacts

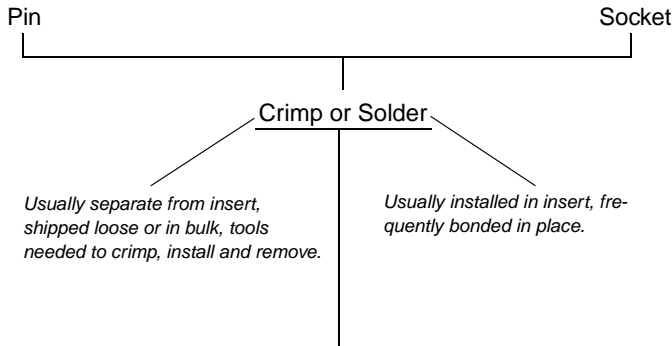

Contact Options:
Solderless Wrap (Wire Wrap),
PC Tail, Coaxial, Thermocouple,
Triaxial, Fiber Optic, Filter

Contact Sizes

Contact Size	22D	22M	22	20	16
American Wire Gauge Wire Size (AWG)	22-28	24-28	22-26	20-24	16-22

Contact Size	12	8	4	0
American Wire Gauge Wire Size (AWG)	12-14	8-10	4-6	0-2

Accessories

- Adapters
 - straight, 90°, 75°
 - conduit, environmental, open wire bundle, EMI, etc.
- Compression ring – wire seal
- Clamp – cable sealing
- Stain relief – clamp, kellems grip
- Potting boot
 - straight, angle, universal

Know the Language

25 Common terms you should know

- **Shell** - Houses insert and contacts
- **Insert** - The dielectric or insulating inner core, holds contacts
- **Coupling Nut** - Outer threaded or grooved ring which holds mated pair together
- **Jam Nut** - Nut that holds receptacle to a panel
- **Bayonet Coupling** - A non-threaded, ramp type of coupling
- **Contacts** - Mechanical tip to which electrical engagement is accomplished
- **Pin Contact** - Male half of a mated pair of contacts*
- **Socket Contact** - Female half of a mated pair of contacts
- **Solder Contact** - A contact to which wire is joined by soldering
- **Crimp Contact** - A contact to which wire is joined by mechanical squeeze
- **Plug** - The cable/coupling half of a mating pair
- **Receptacle** - The panel/receiving half of a mating pair
- **Mating Pair** - Two connectors that couple together. Shell size insert arrangement and rotation must be compatible
- **Plating** - The metal finish applied to contacts and or shell components (protective) to resist corrosion and wear
- **Grommet** - Resilient part at back of insert (attached or separate); gives wire moisture seal
- **Gland** - Resilient ring in rear accessory, provides seal on jacketed cable
- **Sealing Plug** - Plastic type slug, placed in unused grommet holes to seal
- **Grounding Fingers** - A metal strap around plug shell for positive shell-to-shell conductivity/shielding
- **Hermetic** - A connector with fused glass insert for air tightness
- **Mating/Unmating Forces** - Torque required to couple/uncouple a mating pair of connectors or contacts
- **Rear Termination** - An accessory which threads to back of shell
- **Strain Relief** - A type of accessory which clamps wires for support
- **Potting Boot** - A type of accessory which forms a mold for potting compound
- **EMI or RFI Backshell** - A type of accessory to terminate wire shielding
- **Interface Seal** - A resilient part on the face of pin inserts which provides moisture seal.

*Note: Male half always goes into female.

SECTION II

Major MIL-Specifications by Type

- **Standard, MIL-C-5015**
 - **Amphenol 97 Series**
 - **Heavy Duty, MIL-C-22992**
 - **Proprietary Variations**
- Older larger series of connectors
 - Found on many pieces of military equipment and commercial applications
 - Mostly heavy current carrying connectors
 - Early types had only solder type contacts
 - Later revision to MIL Spec also added crimp type contacts
 - Amphenol supplies the solder type to the MIL Spec
 - Amphenol supplies both solder and crimp versions under proprietary part numbers
 - Several variations of basic MIL-C-5015 and MIL-C-22992 types are available in the same and additional contact arrangements, such as the QWL, QWLD, 10-214000 Series, 10-244000 Series and others.
 - See Amphenol catalog sections:
 - MIL-C-5015 Cylindrical 12-020,
 - MIL-C-5015 Modifications 12-021,
 - Heavy Duty Cylindrical 12-052,
 - Commercial Aircraft Cylindrical 12-101,
 - 97 Series (MIL-C-5015 Proprietary) 12-022,
 - GT Series Bayonet 12-024.
 - Basic part number for MIL-C-5015 Series as supplied by Amphenol is MS310X A, C, E, F or R
 - MIL-C-5015 threaded coupling - 1 key/keyway shell polarization

MIL-C-5015 Part Number

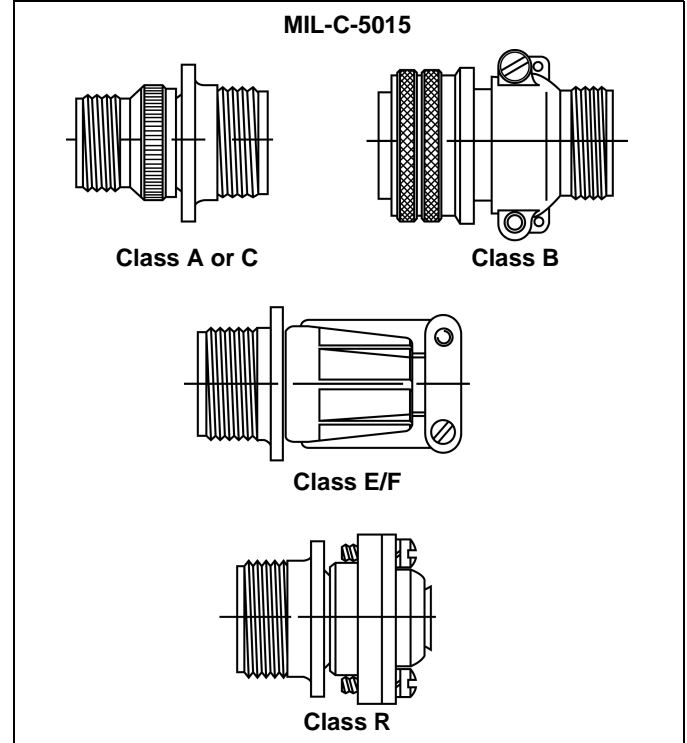
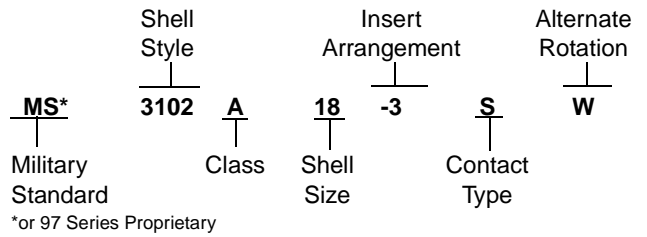

MIL-C-5015 Shell Styles	
3100	Wall Mount Receptacle
3101	Cable Connecting Receptacle*
3102	Box Mount Receptacle
3106	Straight Plug
3108	90° Plug
3107	Quick Disconnect Plug (97 Series only)

Mating Halves

- Plugs: MS3106, MS3107, MS3108 or 97-3106, 97-3107, 97-3108
- Receptacles: MS3100, MS3102, MS3101, 97-3101, 97-3100, 97-3102

Other Non-MIL-Mates, Flange Mounted

- Flange Mounted Plug: FP3106, 97-5105
- Thru-bulkhead Receptacle: TBF

See also 10-74XXX and 10-873XX in catalog section MIL-C-5015 Mods. for jam nut receptacles (Non-MIL)

Contact Sizes

Contact Size	16	12	8	4	0
American Wire Gauge Wire Size (AWG)	16-22	12-14	8-10	4-6	0-2

* This connector style is sometimes referred to as a cable connecting "plug." It does, however, mate with either a straight or 90 degree plug.

Alternate Positions of Insert Arrangements

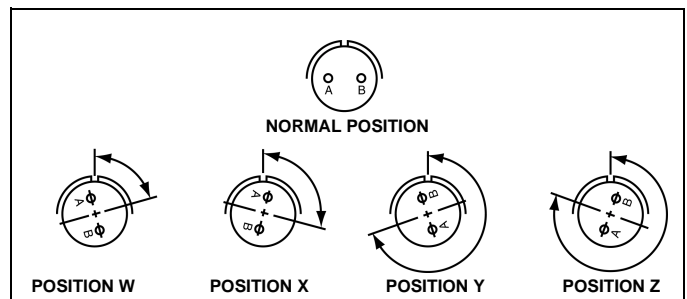

Heavy Duty Cylindrical Connectors

- **Class L** - for the heaviest loads
 - Current range 40 to 200 amperes
 - Direct current or single/three phase, 60/400 Hertz alternating current
 - Automatic grounding for safety
- **QWLD** - for most power and control circuits
 - Military qualified connectors and commercial equivalents available
 - Increased shell size for greater durability than similar standard connectors
- **Class L and QWLD** have 5 key/keyway shell polarization and double stub thread coupling
- **QWL** – a more economical, compact heavy duty design for commercial power and control applications; single key shell polarization and double stub thread coupling

MIL-C-22992 Series Connectors

Classes C, R and L

Part Number Breakdown

The ordering procedure for QWLD MS-Approved Connectors is illustrated by part number MS17343R20N27PW as shown below:

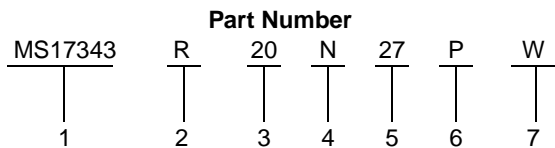

See code below:

1. MS Numbers
 - MS17343 designates wall mount receptacle
 - MS17344 designates straight plug
 - MS17345 designates cable connecting receptacle
 - MS17346 designates box mount receptacle
 - MS17347 designates jam nut receptacle with rear accessory threads (wall mount)
 - MS17348 designates jam nut receptacle (box mount)
2. Class
 - C designates pressurized; used where circuit integrity is protected by a pressure differential
 - R designates environmental; (see Heavy Duty Cylindrical catalog 12-052 for definition)
3. Shell Size
 - Available in shell sizes 12 through 44. See catalog 12-052 for dimensional data
4. Shell Finish
 - C for conductive or N for non-conductive
5. Insert Arrangement
 - Current MS insert arrangements are listed in catalog 12-052, Heavy Duty Cylindrical
6. Contact Type
 - “P” designates pin contacts; “S” for socket contacts

7. Alternate Insert Rotations:

Used to prevent cross-mating of connectors. Absence of a letter in this space indicates normal (0°) position of the insert. See catalog for alternate insert rotation illustrations.

See catalog 12-052 for proprietary equivalents such as 10-194XXX Series. Also see catalog 12-053 for QWL Series.

The ordering procedure for Class “L” Connectors is illustrated by part number MS90555C32412SY as shown below:

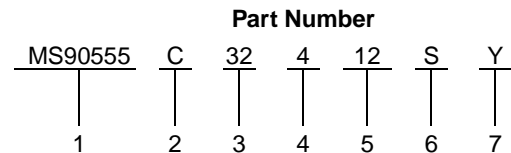

See code below:

1. MS Numbers
 - MS90555 designates wall mount receptacle (power source)
 - MS90556 designates straight plug
 - MS90557 designates cable connecting receptacle without coupling ring
 - MS90558 designates wall mount plug with coupling ring (equipment end)
2. Shell Finish
 - C (conductive) for AC or N (non-conductive) for DC circuits
3. Shell Size
 - Relates directly to current carrying capability
 - Size 28 – 40 amperes
 - Size 32 – 60 amperes
 - Size 44 – 100 amperes
 - Size 52 – 200 amperes
4. Main shell Key/keyway Position
 - N designates normal position. Three other positions (4, 5 and 6) of the main shell key/keyway prevent cross-mating or incompatible voltages. Refer to the individual connector style descriptions in catalog 12-052 for applicability.
5. Insert Arrangement
 - Determined by connector size (current carrying capability) and cable configuration to be accommodated. See catalog for insert arrangement pattern illustrations.
6. Contact Type
 - “P” designates pin contacts. “S” for socket contacts. MS90555 and MS90557 are supplied with socket contacts only. MS90556 and MS90558 are supplied with pin contacts only.
7. Alternate Insert Rotation
 - Used to prevent cross-mating of incompatible frequencies. Absence of a letter in this space indicates normal (0°) position of the insert. See catalog for individual insert arrangement description.

SECTION III

Major MIL-Specifications by Type

- Miniature, MIL-C-26482

Miniature PT-Types MIL-C-26482

- Widely used smaller connectors
- Extensive use on military equipment including aircraft as well as commercial applications
- Available with either crimp or solder type contacts
- 3 point bayonet coupling
- Popular low cost series
- 5 Key/keyway shell polarization
- Amphenol supplies MIL-Spec types as well as proprietary versions
- MS311X or PT, solder type contacts (Series 1)
- MS312X or PT-SE, crimp type contacts (front release) (Series 1)
- MS347X or PTS-DR, crimp type contacts (rear release) (Series 2)
- Modifications of Basic Series are:
 - PT-CE, crimp type contacts (front release) no MIL P/N, intermates with MS connectors
 - PC, double stub threaded coupling - (available with either crimp or solder contacts) no MIL P/N, does not intermate with PT types
 - SP, same as PT except wider flanges for back panel mounting, anodic coating, no MIL P/N, intermates with MS connectors
 - DC, same as PT except resistant to aircraft fluids, no MIL P/N, intermates with MS connectors
 - Other modifications and specials available
- For details on above series see Amphenol catalog sections:
 - “Miniature Cylindrical” 12-070
 - “Commercial Aircraft Cylindricals” 12-101.

MIL-C-26482 Series 2 is the same as MIL-C-83723 Series 1 and will intermate with all PT connectors. The Series features rear removable contacts – accessories are ordered separately. MIL-C-83723 Series 1 has been superseded by MIL-C-26482 Series 2.

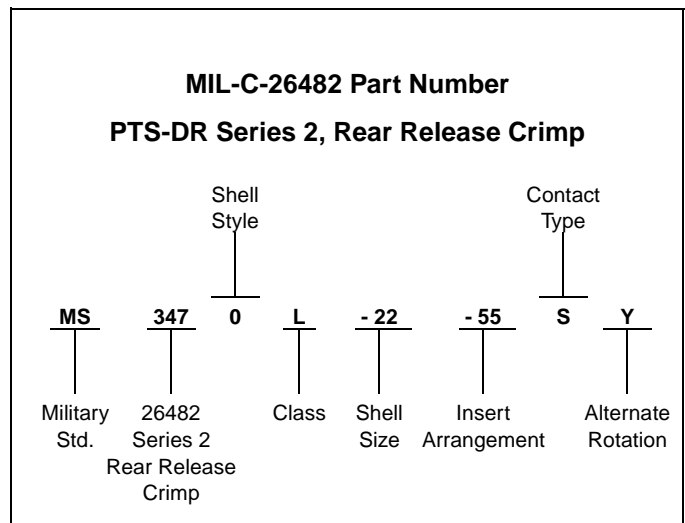
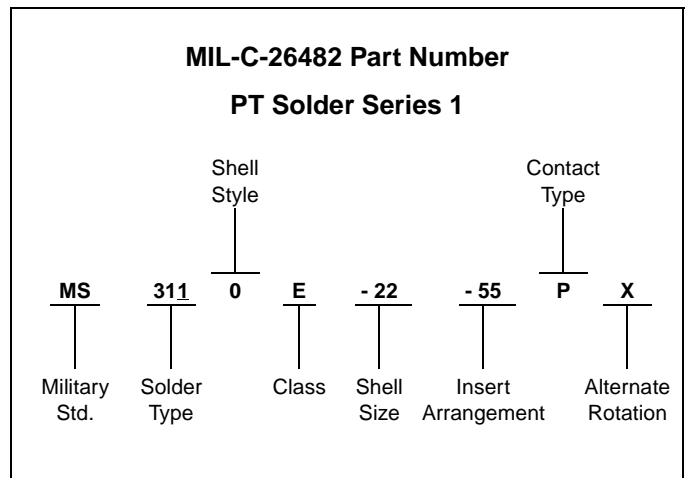
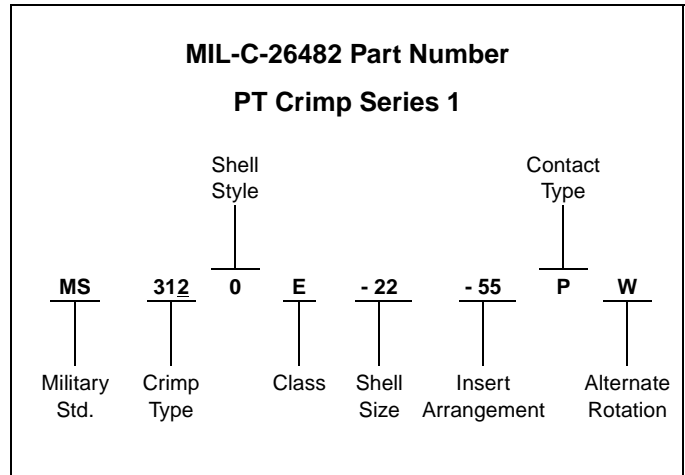

PTS-DR
Part Number Breakdown

To more easily illustrate ordering procedure, part number PTS00DRL-18-32PW() is shown as follows:

PTS	00	DR	L	-18	-32	P	W	()
1	2	3	4	5	6	7	8	9

See code below:

1. Connector Type
Electroless nickel alloy plate 200°C, conductive finish standard
"PTS" designates bayonet lock connector
"PTGS" designates plug with grounding fingers
"PTPS" designates wall mounting receptacle with wide flange
2. Shell Style
"00" designates wall mounting receptacle
"01" designates cable connecting receptacle
"06" designates straight plug
"07" designates jam nut receptacle
3. Retention System
"DR" designates dielectrically retained contacts
4. Service Class
"L" designates fluid resistant, environmental
Class "E" has been superseded by Class "L"
5. Shell Size
"18" designates shell size. Shell sizes 8 through 24 available.
6. Insert Arrangement
"18 - 32" designates insert arrangement
7. Contacts
"P" designates pin contacts
"S" designates socket contacts
8. Insert Rotation
"W", "X", "Y", "Z" designate that insert is rotated in its shell from "normal" position. No letter required for normal (no rotation) position.
9. Finish Variation Suffix
Indicate optional finishes as follows:
(005) anodic coating - Alumilite® (200°C)
(014) olive drab cadmium plate over nickel (175°C)
(023) electroless nickel (standard on PTS-DR) (200°C)

MS/PTS-DR
MIL-C-26482, Series 2

To more easily illustrate ordering procedure, part number MS3470L18-32PW is shown as follows:

MS	347	0	L	18	-32	P	W
1	2	3	4	5	6	7	8

See code below:

1. "MS" designates Military Standard
2. Specification Number
"347" designates basic family number for MIL-C-26482, Series 2 crimp type
3. Shell Style
"0" designates narrow flange wall mounting receptacle
"1" designates cable connecting receptacle
"2" designates wide flange wall mounting receptacle
"4" designates jam nut receptacle
"5" designates plug with grounding fingers
"6" designates straight plug
4. Service Class
"A" designates grommet seal, 200°C, non-conductive anodic coating
"L" designate fluid resistant, 200°C, conductive electroless nickel finish
"W" designates fluid resistant, 175°C, olive drab cadmium over nickel, conductive finish, 500 hr. salt spray
5. Shell Size
"18" designates shell size. Shell sizes 8 through 24 available.
6. Insert Arrangement
"18 - 32" designates insert arrangement
7. Contact Configuration
"P" designates pin contacts
"S" designates socket contacts
8. Insert Rotation
"W", "X", "Y", "Z" designate that insert is rotated in its shell from "normal" position. No letter required for normal (no rotation) position.

Miniature Crimp Connectors Part Number Breakdown

Proprietary Part Number Construction for Miniature Crimp Connectors

To more easily illustrate ordering procedures, part number PT00SE-20-41PW (SR) is shown as follows:

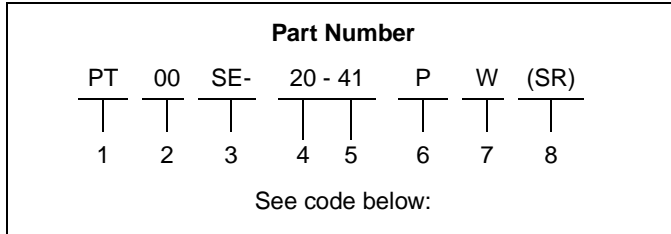

1. Connector Family

PT designates standard olive drab cadmium plated Tri-Lock coupling connector

SP designates connector similar to PT except for anodic coating and larger flange and mounting holes for back panel mounting of receptacles

2. Shell Style

- "00" designates wall mount receptacle
- "01" designates cable connecting receptacle
- "02" designates box mount receptacle
- "06" designates straight plug
- "07" designates jam nut receptacle
- "08" designates 90° plug

3. Service Class

- "SE" designates environmental crimp
 - "SP" designates potted type crimp
- Both of the above are Amphenol proprietary versions of the MIL-C-26482 Series 1 crimp contact connector and offer 15 lbs. contact retention for size 20 contacts, 25 lbs. for size 16 contacts.
- "CE" designates environmental crimp
 - "CP" designates potted type crimp
- Both of the above are original Amphenol crimp connectors and offer 7 lbs. contact retention for size 20 contacts, 9 lbs. for size 16 contacts.

4. "20" designates shell size. Shell sizes available are 8 through 24.

5. "20-41" designates insert arrangement

6. "P" designates pin contacts; "S" for socket contacts

7. "W" designates that insert is rotated in its shell from the standard position to alternate position W. The basic rotations are W, X, Y, and Z. No letter required for normal (no rotation) position.

8. "SR" designates a strain relief clamp. Deviation suffixes would be inserted here. For example, (005) would indicate the metal parts (except contacts) would have anodic coating.

Part Number Nomenclatures for MS/PT Crimp Connectors to MIL-C-26482 Specification

To more easily illustrate ordering procedures, part number MS3120E-20-41PW is broken down as follows:

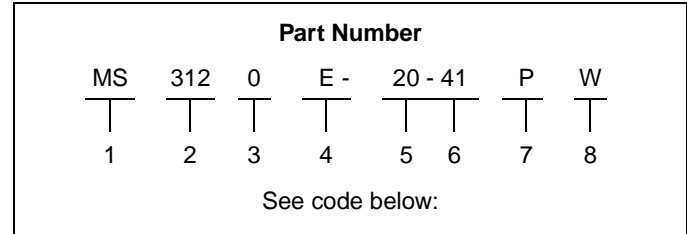

1. "MS" designates Military Standard

2. "312" designates basic family number for MIL-Spec 26482 crimp type

3. Shell Style

- "0" designates wall mount receptacle
- "1" designates cable connecting receptacle
- "2" designates box mount receptacle
- "4" designates jam nut receptacle
- "6" designates straight plug
- "7" designates box mount receptacle with dual mounting holes
- "8" designates wall mount receptacle with dual mounting holes

4. Service Class

- "E" designates environmental resisting connector
- "F" designates environmental resisting connector with strain relief
- "P" designates potted type with potting boot

5. "20" designates shell size. Shell sizes available are 8 through 24.

6. "20-41" designates insert arrangement

7. "P" designates pin contacts; "S" for socket contacts

8. "W" designates that the insert is rotated in its shell from the standard position to alternate position W. The basic rotations are W, X, Y, and Z. No letter required for normal (no rotation) position.

Cross Reference - Commercial PT to Comparable Military MS Types			
Amphenol P/N	MS P/N	Amphenol P/N	MS P/N
PT00SE	MS3120E	PT06SE(SR)	MS3126F
PT01SE	MS3121E	MF00SE(SR)	MS3128F
PT02SE	MS3122E	PT07SE(SR)	MS3124F
PT06SE	MS3126E	PT08SE(SR)	None
MF02SE	MS3127E	PT00SP	MS3120P
MF00SE	MS3128E	PT01SP	MS3121P
PT07SE	MS3124E	PT02SP	MS3122P
PT08SE	None	PT06SP	MS3126P
PT00SE(SR)	MS3120F	PT07SP	MS3124P
PT01SE(SR)	MS3121F		

Miniature Solder Connectors Part Number Breakdown

Part Number Nomenclature for Miniature Solder Connectors

To more easily illustrate ordering procedures, part number PT00A-20-41PW (SR) is shown as follows:

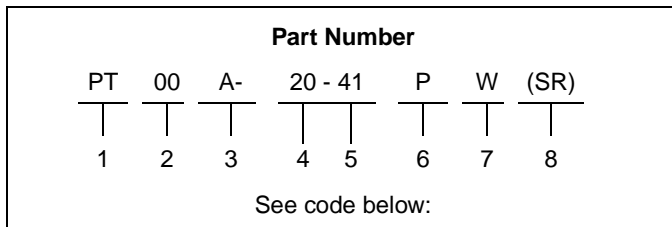

1. Connector Family

PT designates standard olive drab cadmium plated Tri-Lock coupling connector. This is the Amphenol® proprietary version of the MIL-C-26482 solder contact connector.

PC designates a bright cadmium plated connector with double stub thread coupling

SP designates connector similar to PT except for anodic coating and larger flange and mounting holes for back panel mounting

2. Shell Style

“00” designates wall mount receptacle

“01” designates cable connecting receptacle

“02” designates box mount receptacle

“06” designates straight plug

“07” designates jam nut receptacle

PTB designates thru-bulkhead receptacle

PTI designates solder mount receptacle

3. Service Class

“A” designates general duty backshell

“C” designates pressurized receptacle

“E” designates environmental resisting with grommet and nut

“P” designates potted with potting boot

“W” designates clamp assembly for moisture-proofing, multi-jacketed cables

“H” designates hermetic seal receptacle

4. “20” designates shell size. Shell sizes available are 6 through 24.

5. “20-41” designates insert arrangement

6. “P” designates pin contacts; “S” for socket contacts

7. “W” designates that insert is rotated in its shell from the standard position to alternate position W. The basic rotations are W, X, Y, and Z. No letter required for normal (no rotation) position.

8. “SR” designates a strain relief clamp. Deviation suffixes would be inserted here. For example, (005) would indicate the metal parts (except contacts) would have alumilite plating.

Part Number Nomenclatures for MS/PT Solder Connectors to MIL-C-26482 Specification

To more easily illustrate ordering procedures, part number MS3110E-20-41PW is shown as follows:

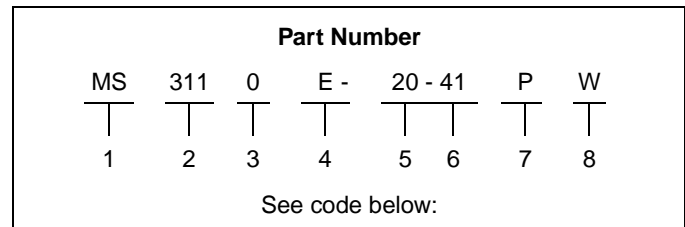

1. “MS” designates Military Standard

2. “311” designates basic family number for MIL-Spec 26482 solder type

3. Shell Style

“0” designates wall mount receptacle

“1” designates cable connecting receptacle

“2” designates box mount receptacle

“4” designates jam nut receptacle

“6” designates straight plug

4. Service Class

“E” designates environmental resisting connector with grommet and clamping nut

“F” designates environmental resisting connector with grommet and strain relief

“P” designates potted type with potting boot

5. “20” designates shell size. Shell sizes available are 8 through 24.

6. “20-41” designates insert arrangement

7. “P” designates pin contacts; “S” for socket contacts

8. “W” designates that the insert is rotated in its shell from the standard position to alternate position W. The basic rotations are W, X, Y, and Z. No letter required for normal (no rotation) position.

Cross Reference - Commercial PT to Comparable Military MS Types			
Amphenol P/N	MS P/N	Amphenol P/N	MS P/N
PT00A	None	PT00E(SR)	MS3110F
PT01A	None	PT01E(SR)	MS3111F
PT02A	None	PT02E(SR)	None
PT06A	None	PT06E(SR)	MS3116F
PT07A	None	PT07E(SR)	MS3114F
PT00C	None	PT00P	MS3110P
PT02C	None	PT01P	MS3111P
PT07C	None	PT02P	None
PTB	MS3119Ref	PT06P	MS3116P
		PT07P	MS3114P
PT00E	MS3110E	PT00W	None
PT01E	MS3111E	PT01W	None
PT02E	MS3112E	PT02W	None
PT06E	MS3116E	PT06W	None
PT07E	MS3114E	PT02H	None
		PT07H	MS3114H
		PT1H	MS3113H

Miniature Shell Styles

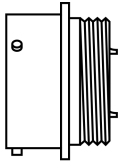
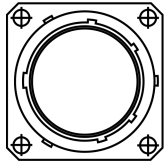

Wall Mount Receptacle

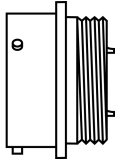
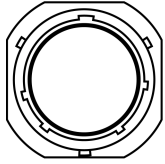

Cable Connecting or Line Mount Receptacle*

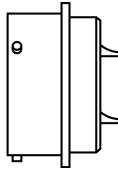
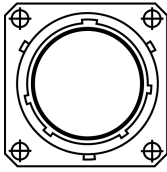

Box Mount Receptacle

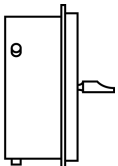
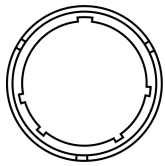

Solder Mount Receptacle (Hermetic)

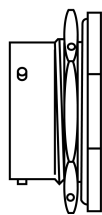
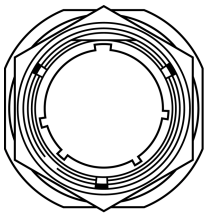

Jam Nut Receptacle

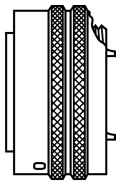
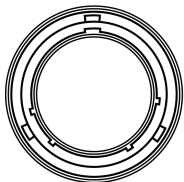

Straight Plug

Also see PTB - Thru-bulkhead, double-ended receptacle in Miniature Cylindrical catalog.

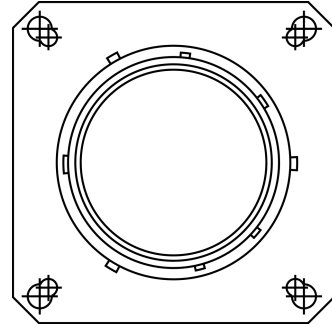

Wide Flange - Back Panel Mount:
MS3127 Box Mount, MS3128 Wall Mount

MIL-C-26482



Class E

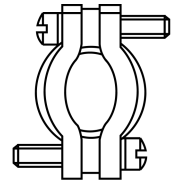

Class F

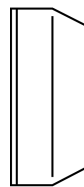

Class P

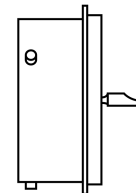

Class H

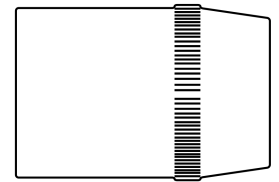

Class W
(Non-MIL)

Shell Sizes

6, 8, 10, 12, 14, 16, 18, 20, 22, 24

Contact Sizes

Contact Size	20	16	12
American Wire Gauge Wire Size (AWG)	20-24	16-20	12-14

* This connector style is sometimes referred to as a cable connecting "plug." It does, however, mate with either a straight or 90 degree plug.

SECTION IV

Major MIL-Specifications by Type

- Subminiature, MIL-C-38999
- MIL-C-27599

Subminiature - JT/LJT, Tri-Start, SJT

- Preferred for new design by the Military
- Greatest growth potential of all cylindricals
- “State of the Art” technology and performance
- MIL-C-27599 has molded-in solder type contacts
- MIL-C-38999 has rear release, crimp removable contacts
- SJT has features of both the JT and LJT and is a NATO preferred connector in Europe
- MIL-C-38999 Series I & II will not intermate
- MIL-C-27599 Series I & II will not intermate
- MIL-C-38999 and MIL-C-27599, Series I and II will intermate respectively
- For more information, see Amphenol catalog section:
 - 12-090, Subminiature Cylindrical Connectors designed to MIL-C-38999 and MIL-C-27599
 - 12-092, Tri-Start Connector - MIL-C-38999 Series III
 - 12-091, SJT - Proprietary MIL-C-38999 type
 - 12-130, Coaxial Contact Catalog

MIL-C-27599

Series I (LJT-Solder)

- 100% scoop-proof
- Molded-in solder type contacts
- Options include PCB, wire wrap contacts
- High contact density (up to 128 contacts)
- Shell grounding fingers standard on all plugs
- Intermateable with MIL-C-38999 Series I
- Bayonet coupling
- 5 key/keyway polarization with 4 alternate rotations

Series II (JT-Solder)

- Low profile, light-weight, non-scoop-proof
- Molded-in solder type contacts
- Options include PCB, wire wrap contacts
- High contact density (up to 128 contacts)
- Shell grounding fingers available as option on plug
- Intermateable with MIL-C-38999 Series II
- Bayonet coupling
- 5 key/keyway polarization with 4 alternate clockings

MIL-C-38999

Series I (LJT-R)

- 100% scoop-proof
- High density arrangements (up to 128 contacts)
- Contact sizes 12 through 22D plus size 16, 12, 8 coax, and size 8 twinax
- Bayonet coupling
- DOD preferred
- Corrosion resistant (500 hr. salt spray) finish available
- Removable crimp, PCB, wire wrap, twinax, and coax contacts available
- Options include Hermetics, Filters and Thermocouples
- 5 key/keyway polarization with 4 alternate rotations
- Shell grounding fingers are standard on all plug
- Triple-web grommet seal
- Available in a Fail Safe Lanyard Release plug: see Amphenol catalog section 12-160 for additional Fail Safe Lanyard Release information.

Series II (JT-R)

- High density arrangements (up to 128 contacts)
- Low silhouette, light-weight non-scoop-proof
- Bayonet coupling
- Contact sizes 12 through 22D plus size 16 & 22 coax
- 5 key/keyway polarization with 4 alternate rotations
- Removable crimp, PCB, wire wrap and coax contacts available
- Corrosion resistant (500 hr. salt spray) finish available
- Options include Hermetics, Filters and Thermocouples
- Shell grounding fingers on plugs are an option
- Triple-web grommet seal
- Available in Fail Safe Lanyard Release plug

**Subminiature JT/LJT
Part Number Breakdown**

PROPRIETARY PART NUMBER

To more easily illustrate ordering procedure, part number JT00RE-22-2PA() is shown as follows:

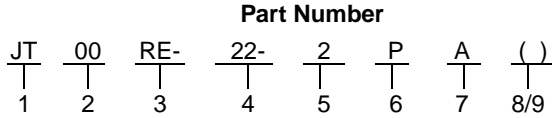

See code below:

1. Connector Type:
 - JT designates standard Junior Tri-Lock connector
 - LJT designates long Junior Tri-Lock connector
 - LJTS JTS designates high temperature connector
 - LJTN JTN designates chemical and fuel resistant
 - JTL designates miniature mounting dimensions
 - JTLN designates miniature mounting dimensions – chemical resistant
 - JTLS designates miniature mounting dimensions – high temperature
 - LJTPQ JTPQ designates back panel mounted wall mounting receptacle
 - LJTP JTP designates back panel mounted box mounting receptacle
 - LJTPN JTPN designates back panel mounted – chemical resistant
 - LJTPS JTPS designates back panel mounted – high temperature
 - JTG* designates plug with grounding fingers
 - JTNG* designates plug with grounding fingers – chemical resistant

*Grounding fingers standard on all LJT plugs.

2. Shell Style
 - “00” designates wall mount receptacle
 - “01” designates line mount receptacle
 - “02” designates box mount receptacle
 - “06” designates straight plug
 - “07” designates jam nut receptacle
 - “08” designates 90-degree plug
 - “I” designates solder mount receptacle – hermetic
3. Service Class: Solder contacts/connectors
 - “P” for potting applications – These connectors are supplied with a potting boot.† All shells are designed with integral features to retain potting boots
 - “A” for general duty applications.
 - “A (SR)” – threaded rear design with strain relief †
 - “C” for pressurized applications
 - “C” (SR)” – threaded rear design with strain relief †
 - “H” for hermetic applications – Fused compression glass sealed inserts. Leakage rate less than .01 micron cu. ft/hr. (1 x 10⁻⁷ cc/sec.) at 15 psi differential.
 - “Y” same as “H” with interfacial seal
 - “T” for MS27599A applications – General duty – pressurized (receptacles only)

“RP” for potting crimp applications – Supplied with spacer grommet and potting boot.†

“RE” for environmental crimp applications – Supplied with a grommet and compression nut† (JT Series only). Can be supplied with strain relief integral with compression nut “RE (SR).”

“RT” for environmental applications – Supplied without rear accessories. Design provides serrations on rear threads of shells. For additional information defining complete description of service class, consult Amphe-nol, Sidney, NY.

4. Shell Size
JT shell sizes available from 8 through 24. LJT shell sizes available from 9 through 25.
5. Insert Arrangement:
22-2 designates insert arrangement. Refer to catalog 12-090 for additional insert patterns.
6. Contact Style
“P” designates pin contacts; “S” designates socket contacts.
7. Alternating Keying
“A” designates alternate keying connector assembly. Other basic alternate keys are “B”, “C” and “D”. No letter required for normal (no rotation) position.
8. “SR” designates a strain relief clamp. Strain reliefs are available only on “A”, “C” and “RE” class connectors.
9. Finish variation suffix.

†Not applicable to box mounting style.

Finish	Military Finish Data	Finish Suffix	Finish plus “SR” Suffix
Cadmium plated nickel base	A		(SR)
Olive drab cadmium plate nickel base	B	(014)	(386)
Electroless nickel	F	(023)	(424)
Anodic coating (Alumilite)	C	(005)	(300)
Chromate treated (Iridite 14-2)		(011)	(344)

MILITARY TYPES

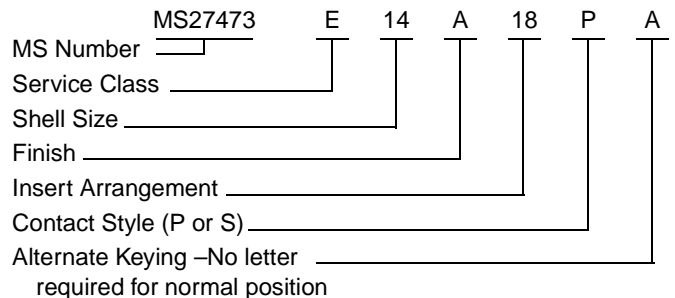

- Military Service Class
- E Environmental, same as RE
 - T Environmental, same as RT
 - Y Hermetically sealed, same as Y
 - P Potting, same as RP

For finish variations see finish data on following page.
For MS depictions and dimensional data see applicable MIL-Spec. (MIL-C-38999, MIL-C-27599).

Subminiature JT/LJT Specifications

CONTACT RATING

Contact Size	Test Current		Maximum Millivolt Drop Crimp*	Maximum Millivolt Drop	
	Solder & Crimp	Hermetic		Solder*	Hermetic*
22M	3	2	45	20	60
22D	5	3	73		85
22	5	3	73	20	85
20	7.5	5	55	20	60
16	13	10	49	20	85
12	23	17	42	20	85
10 Power	33	NA	33	NA	NA

Contact Size	Crimp Well Data		Solder Well Data	
	Well Diameter	Nominal Well Depth	W Diameter	Nominal Well Depth
22M	.028 ± .001	.141	.029 ^{+0.004} _{-.000}	.094
22D	.0345 ±.0010	.141	.034 ^{+0.004} _{-.000}	.094
22	.0365 ±.0010	.141	.036 ^{+0.004} _{-.000}	.094
20	.047 ±. 001	.209	.044 ^{+0.004} _{-.004}	.125
16	.067 ± .001	.209	.078 ^{+0.000} _{-.004}	.141
12	.100 ± .002	.209	.116 ^{+0.004} _{-.002}	.141
10 Power	.137 ± .002	.355	NA	NA

* When tested using silver plated wire

SERVICE RATING**

Service Rating	Suggested Operating Voltage (Sea Level)		Test Voltage (Sea Level)	Test Voltage 50,000 Ft.	Test Voltage 70,000 Ft.	Test Voltage 110,000 Ft.
	AC (RMS)	DC				
M	400	500	1300 VRMS	550 VRMS	350 VRMS	200 VRMS
N	300	450	1000 VRMS	400 VRMS	260 VRMS	200 VRMS
I	600	850	1800 VRMS	600 VRMS	400 VRMS	200 VRMS
II	900	1250	2300 VRMS	800 VRMS	500 VRMS	200 VRMS

** Please note that the establishment of electrical safety factors is left entirely in the designer's hands, since he is in the best position to know what peak voltages, switching surges, transients, etc. can be expected in a particular circuit.

FINISH DATA

Aluminum Shell Components Non-Hermetic				
Finish	Suffix		Indicated Finish Standard for JT Types Listed Below	Standard for LJT Types Listed Below
	Military	Proprietary		
Cadmium Plated Nickel Base	MS (A)	-	JT/JTG/JTL/JTP	LJT/LJTP
Anodic Coating (Alumilite)	MS (C)	(005)	JTS/JTPS/JTLS	LJTPS/LJTS
Chromate Treated (Iridite 14-2)		(011)	JTN/JTPN/JTLN	LJTN/LJTPN
Olive Drab Cadmium Plate Nickel Base	MS (B)	(014)		
Electroless Nickel	MS (F)	(023)		

Hermetic Connectors				
Material Finish	Suffix		Indicated Finish Standard for JT Types Listed Below	Indicated Finish Standard for LJT Types Listed Below
	Military	Proprietary		
Carbon Steel Shell Tin Plated Shell and Contacts			JT () H/JT () Y JTL () H/JTL () Y	LJT () Y/LJT () H
Carbon Steel Shell Tin Plated Shell and Gold Plated Contacts	MS (D)			
Stainless Steel Shell Gold Plated Contacts	MS (E)	(162)	JTS () Y JTLS () Y	LJTS () Y

MIL-C-38999 LJT-R/JT-R and Accessories
Cross Reference List

Series or Accessory	MS Part No.	Amphenol Part No.	Description
Ac	MS20047AXX	10-275197-XX7	Cap, Recept. Series I No Chain
Ac	MS20047BXX	10-275197-XX9	
Ac	MS20047FXX	10-275197-XXG	
Ac	MS20048AXX	10-275196-XX7	Cap, Plug Series I, No Chain
Ac	MS20048BXX	10-275196-XX9	
Ac	MS20048FXX	10-275196-XXG	
Ac	MS27342AXX-1	10-440390-XX7 (Series II)	Adapter
Ac	MS27342BXX-1	10-440390-XX9 (Series II)	
Ac	MS27342CXX-1	10-440390-XX5 (Series II)	
Ac	MS27342FXX-1	10-440390-XXG (Series II)	
Ac	MS27342AXX-2	10-241055 Series II	
Ac	MS27342BXX-2	10-457452 Series I	
Ac	MS27342CXX-2		
Ac	MS27342FXX-2		
Ac	MS27352AXX	10-241853-XX7	Cap, Plug Series II, No Chain
Ac	MS27352BXX	10-241853-XX9	
Ac	MS27352CXX	10-241853-XX5	
Ac	MS27352FXX	10-241853-XXG	
Ac	MS27353AXX	10-241856-XX7	Cap, Recept. Series II, No Chain
Ac	MS27353BXX	10-241856-XX9	
Ac	MS27353CXX	10-241856-XX5	
Ac	MS27353FXX	10-241856-XXG	
I	MS27466EXXAXXP/S	LJT00REXX-XXP/S	Wall Mount Receptacle
I	MS27466EXXBXXP/S	LJT00REXX-XXP/S (014)	
I	MS27466EXXFXXP/S	LJT00REXX-XXP/S (023)	
I	MS27466TXXAXXP/S	LJT00RTXX-XXP/S	
I	MS27466TXXBXXP/S	LJT00RTXX-XXP/S (014)	
I	MS27466TXXFXXP/S	LJT00RTXX-XXP/S (023)	
I	MS27466PXXAXXP/S	LJT00RPXX-XXP/S	
I	MS27466PXXBXXP/S	LJT00RPXX-XXP/S (014)	
I	MS27466PXXFXXP/S	LJT00RPXX-XXP/S (023)	
I	MS27467EXXAXXP/S	LJT06REXX-XXP/S	Straight Plug
I	MS27467EXXBXXP/S	LJT06REXX-XXP/S (014)	
I	MS27467EXXFXXP/S	LJT06REXX-XXP/S (023)	
I	MS27467TXXAXXP/S	LJT06RTXX-XXP/S	
I	MS27467TXXBXXP/S	LJT06RTXX-XXP/S (014)	
I	MS27467TXXFXXP/S	LJT06RTXX-XXP/S (023)	
I	MS27467PXXAXXP/S	LJT06RPXX-XXP/S	Straight Plug
I	MS27467PXXBXXP/S	LJT06RPXX-XXP/S (014)	
I	MS27467PXXFXXP/S	LJT06RPXX-XXP/S (023)	
I	MS27468EXXAXXP/S	LJT07REXX-XXP/S	Jam Nut Mount Receptacle
I	MS27468EXXBXXP/S	LJT07REXX-XXP/S (014)	
I	MS27468EXXFXXP/S	LJT07REXX-XXP/S (023)	
I	MS27468TXXAXXP/S	LJT07RTXX-XXP/S	
I	MS27468TXXBXXP/S	LJT07RTXX-XXP/S (014)	
I	MS27468TXXFXXP/S	LJT07RTXX-XXP/S (023)	
I	MS27468PXXAXXP/S	LJT07RPXX-XXP/S	
I	MS27468PXXBXXP/S	LJT07RPXX-XXP/S (014)	
I	MS27468PXXFXXP/S	LJT07RPXX-XXP/S (023)	
I	MS27469YXXDXXP	LJT00YXX-XXP	Wall Mount Recept., Hermetic Seal
I	MS27469YXXEXXP	LJTS00YXX-XXP	
I	MS27470YXXDXXP	LJT07YXX-XXP	Jam Nut Mount Recept., Hermetic Seal
I	MS27470YXXEXXP	LJTS07YXX-XXP	
I	MS27471YXXDXXP	LJTIYXX-XXP	Solder Mount Recept., Hermetic Seal
I	MS27471YXXEXXP	LJTSIYXX-XXP	

Series or Accessory	MS Part No.	Amphenol Part No.	Description
II	MS27472EXXAXXP/S	JT00REXX-XXP/S	Wall Mount Receptacle
II	MS27472EXXBXXP/S	JT00REXX-XXP/S (014)	
II	MS27472EXXCXXP/S	JTS00REXX-XXP/S	
II	MS27472EXXFXXP/S	JT00REXX-XXP/S (023)	
II	MS27472TXXAXXP/S	JT00RTXX-XXP/S	
II	MS27472TXXBXXP/S	JT00RTXX-XXP/S (014)	
II	MS27472TXXCXXP/S	JTS00RTXX-XXP/S	
II	MS27472TXXFXXP/S	JT00RTXX-XXP/S (023)	
II	MS27472PXXAXXP/S	JT00RPXX-XXP/S	
II	MS27472PXXBXXP/S	JT00RPXX-XXP/S (014)	
II	MS27472PXXCXXP/S	JTS00RPXX-XXP/S	
II	MS27472PXXFXXP/S	JT00RPXX-XXP/S (023)	
II	MS27473EXXAXXP/S	JT06REXX-XXP/S	Straight Plug
II	MS27473EXXBXXP/S	JT06REXX-XXP/S (014)	
II	MS27473EXXCXXP/S	JT06REXX-XXP/S	
II	MS27473EXXFXXP/S	JT06REXX-XXP/S (023)	
II	MS27473TXXAXXP/S	JT06RTXX-XXP/S	
II	MS27473TXXBXXP/S	JT06RTXX-XXP/S (014)	
II	MS27473TXXCXXP/S	JT06RTXX-XXP/S	
II	MS27473TXXFXXP/S	JT06RTXX-XXP/S (023)	
II	MS27473PXXAXXP/S	JT06RPXX-XXP/S	
II	MS27473PXXBXXP/S	JT06RPXX-XXP/S (014)	
II	MS27473PXXCXXP/S	JTS06RPXX-XXP/S	
II	MS27473PXXFXXP/S	JT06RPXX-XXP/S (023)	
II	MS27474EXXAXXP/S	JT07REXX-XXP/S	Jam Nut Mount Receptacle
II	MS27474EXXBXXP/S	JT07REXX-XXP/S (014)	
II	MS27474EXXCXXP/S	JTS07REXX-XXP/S	
II	MS27474EXXFXXP/S	JT07REXX-XXP/S (023)	
II	MS27474TXXAXXP/S	JT07RTXX-XXP/S	
II	MS27474TXXBXXP/S	JT07RTXX-XXP/S (014)	
II	MS27474TXXCXXP/S	JTS07RTXX-XXP/S	
II	MS27474TXXFXXP/S	JT07RTXX-XXP/S (023)	
II	MS27474PXXAXXP/S	JT07RPXX-XXP/S	
II	MS27474PXXBXXP/S	JT07RPXX-XXP/S (014)	
II	MS27474PXXCXXP/S	JTS07RPXX-XXP/S	
II	MS27474PXXFXXP/S	JT07RPXX-XXP/S (023)	
II	MS27475YXXDXXP	JT00YXX-XXP	Wall Mount Recept., Hermetic Seal
II	MS27475YXXEXXP	JTS00YXX-XXP	
II	MS27476YXXDXXP	JT02YXX-XXP	Box Mount Recept., Hermetic Seal
II	MS27476YXXEXXP	JTS0YXX-XXP	
II	MS27477YXXDXXP	JT07YXX-XXP	Jam Nut Mount Recept., Hermetic Seal
II	MS27477YXXEXXP	JTS07YXX-XXP	
II	MS27478YXXDXXP	JTIYXX-XXP	Solder Mount Recept., Hermetic Seal
II	MS27478YXXEXXP	JTSIYXX-XXP	
II	MS27479EXXCXXP/S	JTS00REXX-XXP/S	Wall Mount Recept., Inactive, Use MS27472
II	MS27479TXXCXXP/S	JTS00RTXX-XXP/S	
II	MS27480EXXCXXP/S	JTS06REXX-XXP/S	Straight Plug, Inactive, Use MS27473
II	MS27480TXXCXXP/S	JTS06RTXX-XXP/S	
II	MS27481EXXCXXP/S	JTS07REXX-XXP/S	Jam Nut Mount Recept., Inactive, Use MS27474
II	MS27481TXXCXXP/S	JTS07RTXX-XXP/S	
II	MS27482YXXEXXP	JTS00YXX-XXP	Wall Mount Recept., Hermetic Seal, Inactive, Use MS27475
II	MS27483YXXEXXP	JTS07YXX-XXP	Jam Nut Mount Recept., Hermetic Seal, Inactive, Use MS27477

MIL-C-38999 LJT-R/JT-R and Accessories
Cross Reference List (Cont.)

Series or Accessory	MS Part No.	Amphenol Part No.	Description
II	MS27484EXXAXXP/S	JTG06REXX-XXP/S	Straight Plug with Grounding Spring
II	MS27484EXXBXXP/S	JTG06REXX-XXP/S (014)	
II	MS27484EXXFXXP/S	JTG06REXX-XXP/S (023)	
II	MS27484TXAXXP/S	JTG06RTXX-XXP/S	
II	MS27484TXBXXP/S	JTG06RTXX-XXP/S (014)	
II	MS27484TXFXFP/S	JTG06RTXX-XXP/S (023)	
II	MS27484PXXAXXP/S	JTG06RPXX-XXP/S	
II	MS27484PXXBXXP/S	JTG06RPXX-XXP/S (014)	
II	MS27484PXXFXFP/S	JTG06RPXX-XXP/S (023)	
Ac	MS27485AXX	10-528399-XX7	Ring, Potting Boot, Series II
Ac	MS27485BXX	10-528399-XX9	
Ac	MS27485CXX	10-528399-XX5	
Ac	MS27485FXX	10-528399-XXG	
Ac	MS27486-XX-1	10-241912-XX	Potting, Boot Straight, Series II
Ac	MS27486-XX-2	10-241990-XX	Potting, Boot 90 Degree Series II
Ac	MS27487-XX-1	10-450910-XX, Includes MS27489	Kit, EMR Adapter, Straight, Series I & II
Ac	MS27487-XX-2	10-450911-XX	Kit, EMR Adapter, 90 Degree Series I & II,
Ac	MS27488-12	10-405996-12	Plug, Sealing Grommet
Ac	MS27488-16	10-405996-16	
Ac	MS27488-20	10-405996-20	
Ac	MS27488-22	10-405996-24	
Ac	MS27489-XXX	10-352425-XX	
I	MS27490-XX	10-407035-XX5	Contact-Socket
II	MS27491-XX	10-251416-XX5	Contact-Socket
II	MS27492-XX	10-251416-XXH	Contact-Socket, Inactive, use MS27491
II	MS27493-XX	10-251415-XX5	Contact-Pin
II	MS27494-XX	10-251415-XXH	Contact-Pin, Inactive, use MS27493
I & II	MS27495R-XX	11-8675-XX	Tool, Contact, Removable, Metal
I & II	MS27495A-XX	11-8674-XX	Tool, Contact, Assembly, Metal
I	MS27496EXXAXXP/S	LJT02REXX-XXP/S	Box Mount Receptacle
I	MS27496EXXBXXP/S	LJT02REXX-XXP/S (014)	
I	MS27496EXXFXXP/S	LJT02REXX-XXP/S (023)	
II	MS27497EXXAXXP/S	JTPQ00REXX-XXP/S	Back Panel Wall Mount Receptacle.
II	MS27497EXXBXXP/S	JTPQ00REXX-XXP/S (014)	
II	MS27497EXXCXXP/S	JTPSQ00REXX-XXP/S	
II	MS27497EXXFXXP/S	JTPQ00REXX-XXP/S (023)	
II	MS27497TXAXXP/S	JTPQ00RTXX-XXP/S	
II	MS27497TXBXXP/S	JTPQ00RTXX-XXP/S (014)	
II	MS27497TXCXXP/S	JTPSQ00RTXX-XXP/S	
II	MS27497TXFXFP/S	JTPQ00RTXX-XXP/S (023)	
II	MS27497PXXAXXP/S	JTPQ002PXX-XXP/S	
II	MS27497PXXBXXP/S	JTPQ002PXX-XXP/S (014)	
II	MS27497PXXCXXP/S	JTPSQ002PXX-XXP/S	
II	MS27497PXXFXFP/S	JTPQ002PXX-XXP/S (023)	
II	MS27497VXXAXXP/S	JTP00REXX-XXP/S	
II	MS27497VXXBXXP/S	JTP00REXX-XXP/S (014)	
II	MS27497VXXCXXP/S	JTPSQ00REXX-XXP/S	
II	MS27497VXXFXFP/S	JTP00REXX-XXP/S (023)	

Series or Accessory	MS Part No.	Amphenol Part No.	Description
I	MS27498EXXAXXP/S	LJT08REXX-XXP/S	90 Degree Plug, Inactive for Design
I	MS27498EXXBXXP/S	LJT08REXX-XXP/S (014)	
II	MS27499EXXAXXP/S	JT02REXX-XXP/S	Box Mount Receptacle
II	MS27499EXXBXXP/S	JT02REXX-XXP/S (014)	
II	MS27499EXXCXXP/S	JTS02REXX-XXP/S	
II	MS27499EXFXFP/S	JT02REXX-XXP/S (023)	
II	MS27500EXXAXXP/S	JT08REXX-XXP/S	90 Degree Plug, Inactive for Design
II	MS27500EXXBXXP/S	JT08REXX-XXP/S (014)	
I	MS27501AXXC	10-421399-XX7	Cover, Plug, with chain
I	MS27501BXXC	10-421399-XX9	
I	MS27501FXXC	10-421399-XXG	
I	MS27502AXXC	10-427406-XX7	Cover Receptacle, with chain
I	MS27502BXXC	10-427406-XX9	
I	MS27502FXXC	10-427406-XXG	
II	MS27503YXXEEXP	JTSIYXX-XXP	
II	MS27504EXXCXXP/S	JTS00REXX-XXP/S	Box Mount Receptacle, Inactive, use MS27499
I	MS27505EXXAXXP/S	LJTP02REXX-XXP/S (023)	Back Panel Wall Mount Receptacle
I	MS27505EXXBXXP/S	LJTP02REXX-XXP/S (014)	
I	MS27505EXXFXXP/S	LJTP02REXX-XXP/S (023)	
I	MS27506AXX-1	10-436792-XX7	Adapter, Strain Relief, Clamp Bars
I	MS27506BXX-1	10-436792-XX9	
I	MS27506FXX-1	10-436792-XXG	
II	MS27506AXX-2	10-433992-XX7	
II	MS27506BXX-2	10-433992-XX9	
II	MS27506CXX-2	10-433992-XX5	
II	MS27506FXX-2	10-433992-XXG	
I & II	MS27507A-XX	10-415693-XX7	
I & II	MS27507B-XX	10-415693-XX9	
I & II	MS27507C-XX	10-415693-XX5	
I & II	MS27507F-XX	10-415693-XXG	
II	MS27508EXXAXXP/S	JTP02REXX-XXP/S	Back Panel Box Mount Receptacle
II	MS27508EXXBXXP/S	JTP02REXX-XXP/S (014)	
II	MS27508EXXCXXP/S	JTPS02REXX-XXP/S	
II	MS27508EXFXFP/S	JTP02REXX-XXP/S (023)	
I & II	MS27509R-XX	10-296943-XX	Tool, Contact Removal and Assembly, Plastic Inactive, use MS27534
I & II	MS27509A-XX	10-296940-XX	
II	MS27510AXXC	10-241801-XX7	Cap, Plug with chain
II	MS27510BXXC	10-241801-XX9	
II	MS27510CXXC	10-241801-XX5	
II	MS27510FXXC	10-241801-XXG	
II	MS27511AXXC	10-241800-XX7	Cap, Receptacle, with chain
II	MS27511BXXC	10-241800-XX9	
II	MS27511CXXC	10-241800-XX5	
II	MS27511FXXC	10-241800-XXG	
II	MS27511AXXR	10-241866-XX7	Cap, Receptacle with wire rope
II	MS27511BXXR	10-241866-XX9	
II	MS27511CXXR	10-241866-XX5	
II	MS27511FXXR	10-241866-XXG	
II	MS27510 ()XXR	10-241864-	Cap, Plug with wire rope
II	MS27511()XXN	10-241802-	Cap, Receptacle, Jam Nut, with chain

MIL-C-38999 LJT-R/JT-R and Accessories
Cross Reference List (Cont.)

Series or Accessory	MS Part No.	Amphenol Part No.	Description
II	MS27512-XXA	10-101917-XX7	Nut, Hex
II	MS27512-XXB	10-101917-XX9	
II	MS27512-XXC	10-101917-XX5	
II	MS27512-XXE	10-260548-XX	
II	MS27512-XXF	10-101917-XXG	
II	MS27513EXXAXXP/S	JT02REXX-XXP/S	Box Mount Receptacle, Full Length Grommet
II	MS27513EXXAXXP/S	JT02REXX-XXP/S (014)	
II	MS27513EXXCXXP/S	JTS02REXX-XXP/S	
II	MS27513EXXFXXP/S	JT02REXX-XXP/S (023)	
I	MS27514-XXA	10-123017-XX7	Nut, Hex
I	MS27514-XXB	10-123017-XX9	
I	MS27514-XXE	10-195959-XX	
I	MS27514-XXF	10-123017-XXG	
I	MS27515EXXAXXP/S	LJTP00REXX-XXP/S	Black Panel Wall Mount Receptacle, Inactive, Use MS27656
I	MS27515EXXBXXP/S	LJTP00REXX-XXP/S (014)	
I & II	MS27534-12	10-538988-12	Tool, Contact Insertion/Removal, Plastic
I & II	MS27534-16	10-538988-16	
I & II	MS27534-20	10-538988-20	
I & II	MS27534-22D	10-538988-22D	
I	MS27535	21-33101-XX	Contact, Socket, Shielded
I	MS27536	21-33102-XX	Contact, Pin, Shielded
I	MS27652EXXFXXP/S	LJTS00REXX-XXP/S (023)	Wall Mount Receptacle Inactive, Use MS27466
I	MS27652TXXFXXP/S	LJTS00RTXX-XXP/S (023)	
I	MS27653EXXFXXP/S	LJTS06REXX-XXP/S (023)	Straight Plug, Inactive, Use MS27467
I	MS27653TXXFXXP/S	LJTS06RTXX-XXP/S (023)	
I	MS27654EXXFXXP/S	LJTPS00REXX-XXP/S (023)	Back Panel Wall Mount Recept. Inactive, Use MS27656
I	MS27654TXXFXXP/S	LJTPS00RTXX-XXP/S (023)	
I	MS27655-XX	10-407035-XXH	Contact, Socket, Inactive, Use MS27490
I	MS27656EXXAXXP/S	LJTPQ00REXX-XXP/S	Back Panel Wall Mount Receptacle
I	MS27656EXXFXXP/S	LJTPQ00REXX-XXP/S (014)	
I	MS27656EXXFXXP/S	LJTPQ00REXX-XXP/S (023)	

Series or Accessory	MS Part No.	Amphenol Part No.	Description
I	MS27656TXXAXXP/S	LJTPQ00RTXX-XXP/S	Back Panel Wall Mount Receptacle
I	MS27656PXXBXXP/S	LJTPQ00RTXX-XXP/S (014)	
I	MS27656PXXFXXP/S	LJTPQ00RTXX-XXP/S (023)	
I	MS27656PXXAXXP/S	LJTPQ00RPXX-XXP/S	Back Panel Wall Mount Receptacle
I	MS27656PXXBXXP/S	LJTPQ00RPXX-XXP/S (014)	
I	MS27656PXXFXXP/S	LJTPQ00RPXX-XXP/S (023)	
I	MS27661EXXAXXP/S	87-538800/74	Straight Plug, Lanyard Release
I	MS27661EXXBXXP/S	88-538800/74	
I	MS27661EXXFXXP/S	91-538800/74	
I	MS27662EXXAXXC	LJTB-XX-XXX	Thru-Bulkhead Mount Receptacle
I	MS27662EXXBXXC	LJTB-XX-XXX	
I	MS27662EXXCXXC	LJTB-XX-XXX	
I	MS27662EXXFXXC	LJTB-XX-XXX	
I & II	MS27663AXX-1	10-482790-XX7	Adapter Nut, Non-Metallic (Nylon Only)
I & II	MS27663BXX-1	10-482790-XX9	
I & II	MS27663CXX-1	10-482790-XX5	
I & II	MS27663FXX-1	10-482790-XX6	
I & II	MS27663AXX-2	10-482494-XX7	Adapter 90 Degree, Non-Metallic (Nylon Only)
I & II	MS27663BXX-2	10-482494-XX9	
I & II	MS27663CXX-2	10-482494-XX5	
I & II	MS27663FXX-2	10-482494-XX6	
II	MS27664EXXAXXP/S	JTPQ00REXX-XXP/S	Back Panel Wall Mount Receptacle, Inactive Use MS27497
II	MS27664EXXBXXP/S	JTPQ00REXX-XXP/S (014)	
II	MS27664EXXCXXP/S	JTPSQ00REXX-XXP/S	
II	MS27664EXXFXXP/S	JTPQ00REXX-XXP/S (023)	
II	MS27664TXXAXXP/S	JTPQ00RTXX-XXP/S	
II	MS27664TXXBXXP/S	JTPQ00RTXX-XXP/S (014)	
II	MS27664TXXCXXP/S	JTPSQ00RTXX-XXP/S	
II	MS27664TXXFXXP/S	JTPQ00RTXX-XXP/S (023)	
I	MS27665		Rack and Panel, Cancelled
	MS27666	DNS	
II	MS27667EXXBXXC	JTB-XX-XX	Thru-Bulkhead UTZ Receptacle
II	MS27667EXXCXXC	JTB-XX-XX	
II	MS27667EXXFXXC	JTB-XX-XX	
	MS27668	DNS	
	MS27669	DNS	
	MS27670	DNS	

Subminiature Tri-Start How to Order

Proprietary Part Number

Amphenol® Tri-Start connectors can be ordered by coded part number. Ordering procedure is illustrated by part number TVPS00RF-9-35PB() as shown below

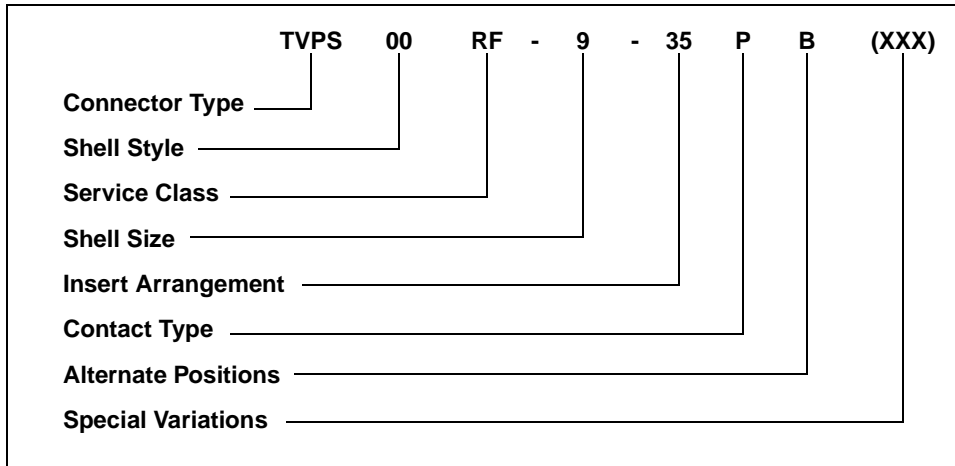

Connector Type

TV designates Tri-Start Series Connector
 TVP designates back panel mounted receptacle
 TVS designates 200 °C rating
 TVPS designates back panel mounted, 200 °C rated receptacle
 For other connector types, consult catalog 12-092.
 For how to order information on Composite Tri-Start Connectors (CTV), consult catalog 12-092.

Shell Style

00 designates wall mount receptacle
 01 designates line receptacle
 02 designates box mount receptacle
 06 designates straight plug
 07 designates jam nut receptacle
 09 designates flange mounted plug
 I designates solder mount receptacle, hermetic only

Service Class

RX non-conductive, anodic coated aluminum, 500 hour salt spray, 200 °C (requires special variation suffix 005)
 RF electroless nickel plated aluminum, optimum EMI shielding effectiveness – 65dB @ 10GHz specification min., 48 hour salt spray, 200 °C
 RGF same as RF, except for ground plane connectors
 RK corrosion resistant stainless steel, firewall capability, plus 500 hour salt spray resistance, EMI – 45 dB @ 10 GHz specification min., 200 °C
 RW corrosion resistant olive drab cadmium plate aluminum, 500 hour extended salt spray, EMI – 50 dB @ 10GHz specification min., 175 °C
 RGW same as RW, except for ground plane connectors

Y hermetic seal, passivated stainless steel, 200 °C
 RS (non-hermetic connectors), nickel plated stainless steel, optimum EMI shielding effectiveness – 65 dB @10 GHz specification min., 48 hour salt spray, 200 °C
 YN (hermetic connectors), nickel plated stainless steel, 200 °C

Shell Size

MIL-C-38999, Size 9 – 25

A	B	C	D	E	F	G	H	J	MIL Shell Size
9	11	13	15	17	19	21	23	25	Amphenol® Shell Size

Insert Arrangement

MIL-C-38999, see catalog 12-092

Contact Type

P designates pin contacts
 S designates socket contacts

Alternate Positions

Locksmith keying - rotation of minor keys. See catalog 12-092.
 "N" not required for normal position

Special Variations

(100) eyelet termination (hermetic)
 (005) anodic coating

**Subminiature Tri-Start
How to Order**

Military Part Number

To more easily illustrate ordering procedure by military designation, part number D38999/20F A35PB is shown as follows:

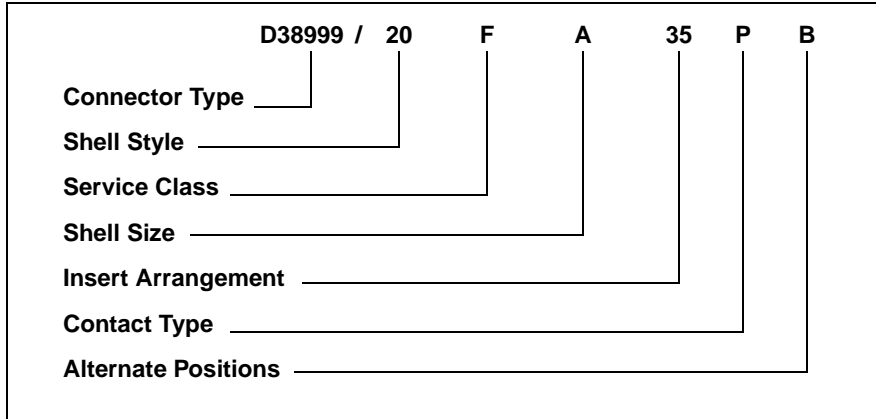

Connector Type

D38999/ designates MIL-C-38999 Series III Connector

For how to order Composite Tri-Start (CTV) Connectors by military designation, consult catalog 12-092.

Shell Style

- 20 designates wall mount receptacle
- 21 designates box mount receptacle, hermetic
- 23 designates jam nut receptacle, hermetic
- 24 designates jam nut receptacle
- 25 designates solder mount receptacle, hermetic
- 26 designates straight plug
- 27 designates weld mount receptacle, hermetic
- 29 designates Lanyard Release plug with pin contacts*
- 30 designates Lanyard Release plug with socket contacts*
- 31 designates Lanyard Release plug with MIL-STD-1760 pin contacts*

* For ordering Amphenol® Lanyard Release Connectors, consult catalog 12-160. Ordering procedure for Lanyard Release Connectors includes specifying lanyard length codes and designating Style 1 or 2.

Service Class

- C non-conductive, anodic coated aluminum, 500 hour salt spray, 200 °C (environmental resisting)
- F electroless nickel plated aluminum, optimum EMI shielding effectiveness – 65dB @ 10GHz specification min., 48 hour salt spray, 200 °C (conductive, environmental resisting)
- K corrosion resistant stainless steel, firewall capability, plus 500 hour salt spray resistance, EMI – 45 dB @ 10 GHz specification min., 200 °C
- W corrosion resistant olive drab cadmium plate aluminum, 500 hour extended salt spray, EMI – 50 dB @ 10GHz specification min., 175°C

- Y hermetic seal, passivated stainless steel, 200 °C
- S (non-hermetic connectors), nickel plated stainless steel, optimum EMI shielding effectiveness – 65 dB @10 GHz specification min., 48 hour salt spray, 200 °C
- N (hermetic connectors), nickel plated stainless steel, 200 °C
- J olive drab cadmium plate (175°C) composite, environmental resisting, corrosion resistant
- M electroless nickel plate (200°C) composite, environmental resisting, corrosion resistant

Shell Size

MIL-C-38999, Size 9 – 25

A	B	C	D	E	F	G	H	J	MIL Shell Size
9	11	13	15	17	19	21	23	25	Amphenol® Shell Size

Insert Arrangement

MIL-C-38999, see catalog 12-092

Contact Type

- H designates pin contacts (1500 cycle)
- J designates socket contacts (1500 cycle)
- P designates pin contacts (500 cycle)
- S designates socket contacts (500 cycle)

Alternate Positions

Locksmith keying - rotation of minor keys. See catalog 12-092. Use "N" for normal position

Amphenol® Federal Vendor Identification/FSCM 77820

Subminiature Tri-Start Specifications

MIL-C-38999, Series III (TV)

- 100% scoop-proof
- High density contact arrangements
- Contact sizes 12 through 22D plus size 8, 12, 16 coax, and size 8 twinax
- Removable crimp, PCB, wire wrap, coax, triax, twinax and fiber optic contact styles available
- Options include Hermetics, Filters and Thermocouples
- Self-locking, quick disconnect threaded coupling
- Corrosion resistant - shells of stainless steel or cadmium plate over nickel withstand a 500 hour salt spray exposure
- Moisture resistance - improved interfacial seal design prevents electrolytic erosion of contacts
- EMI shielding - designed to obtain metal-to-metal coupling, the TV connector provides a superior EMI shielding capability
- Vibration/Shock - operates under severe, high temperature shock and vibration testing through 200° C
- Firewall capability - available in stainless steel shell, Class K
- Locksmith keying - 5 keyway polarization provides 5 alternate rotations
- Shell grounding fingers are standard on all plugs
- Triple-web grommet seal
- DOD preferred
- Available in a Fail Safe Lanyard Release plug
- See catalog 12-092

CONTACT RATING

Contact Size	Test Current		Maximum Millivolt Drop*	
	Crimp	Hermetic	Crimp**	Hermetic**
22D	5	3	73	85
20	7.5	5	55	60
16	13	10	49	85
12	23	17	42	85
10 (Power)	33	NA	33	NA

* Maximum Millivolt Drop data is determined by measuring resistance of mated contacts from end to end

** When using silver plated wire

Contact Size	Crimp Well Data		Hermetic Well Data	
	Well Diameter	Nominal Well Depth	Well Diameter	Min. Well Depth
22D	.0345 ± .0010	.141	.036 +.004 -.000	.094
20	.047 ± .001	.209	.044 +.004 -.000	.125
16	.067 ± .001	.209	.078 +.004 -.002	.141
12	.100 ± .002	.209	.116 +.004 -.002	.141
10 (Power)	.137 ± .002	.355	NA	NA

FINISH DATA

Non-Hermetic Shell Components		
Finish	Service Class	
	Military	Proprietary
Anodic Coating (Non-Conductive)	C	RX***
Electroless Nickel	F	RF
Olive Drab Cadmium Plate Nickel Base	W	RW
Stainless Steel with Nickel Plate	S	RS
Stainless Steel	K	RK
Olive Drab Cadmium Plate, Composite	J	RW
Electroless Nickel Plate, Composite	M	RF
Hermetic Connectors		
Material/Finish	Suffix	
	Military	Proprietary
Stainless Steel	Y	Y
Stainless Steel, Nickel Plate	N	YN

*** Add suffix (005) to part number

SERVICE RATING†

Service Rating	Suggested Operating Voltage (Sea Level)		Test Voltage (Sea Level)	Test Voltage 50,000 Ft.	Test Voltage 70,000 Ft.	Test Voltage 110,000 Ft.
	AC (RMS)	DC				
M	400	550	1300 VRMS	550 VRMS	350 VRMS	200 VRMS
N	300	450	1000 VRMS	400 VRMS	260 VRMS	200 VRMS
I	600	850	1800 VRMS	600 VRMS	400 VRMS	200 VRMS
II	900	1250	2300 VRMS	800 VRMS	500 VRMS	200 VRMS

† Please note that the establishment of electrical safety factors is left entirely in the designer's hands, since he is in the best position to know what peak voltages, switching surges, transients, etc. can be expected in a particular circuit.

**Subminiature SJT
Features, Part Number Breakdown**

- 100% scoop-proof – Basic LJT lengths
- Basic JT mounting dimensions
- Bayonet coupling
- 5 key/keyway polarization with 4 alternate rotations
- Rear release crimp contacts
- PCB, wire wrap, twinax and coax contacts available
- High density insert patterns available
- Shell grounding fingers are an option on the plug
- Options include Hermetics, Filters and Thermocouples
- See catalog 12-091

SJT How to Order

PART NUMBER

To more easily illustrate ordering procedure, part number SJT00RT-18-66PA() is shown as follows:

SJT	00	RT	18	-	66	P	A	()
1	2	3	4		5	6	7	8

See code below:

1. Connector Type

SJT designates standard scoop-proof Junior Tri-Lock Connector

SJTS designates high temperature connector

SJTG designates plug with grounding fingers

SJTP designates back panel mounted

2. Shell Style

00 designates wall mount receptacle

06 designates straight plug

07 designates jam nut receptacle

I designates solder mount receptacle – hermetic

3. Service Class

“Y” for hermetic applications, fused compression glass sealed inserts. Leakage rate less than .01 micron cu. ft./hr. (1×10^{-7} cc/sec.) at 15 psi differential, with interfacial seal.

“RT” for environmental applications - supplied without rear accessories. Design provides serrations on rear threads of shells.

For additional information defining complete description of service class, consult Amphenol, Sidney, NY.

4. SJT shell sizes available from 8 through 24.

5. – 66 designates insert arrangement

6. P designates pin contacts; S for socket contacts

7. A designates a rotated connector assembly (alternate keying). Other basic rotations are B, C and D. No letter required for normal, (no rotation) position

8. Finish variation suffix

MIL-SPEC Cross Reference Data and General Information

MIL-Spec	Description	Amphenol Proprietary Mates	Contact Termination & Removal	Contact Sizes in Series (Wire Gauge)	Coupling Method	Other Notes
MIL-C-5015	Power type connectors, large contacts Older series had solder contacts; newer has crimp	CS, SM, TBF 10-72XXX, GP, SC, SF, SG, SB, FP, 10-214XXX, 10-244XXX, 10-87XXX, etc.	Solder or crimp, front or rear removal	16 thru 0	Threaded	310X solder, 340X crimp F. R., 345X crimp R. R., GT Series Reverse Bayonet Coupling
MIL-C-26482 * Series 1 crimp	Miniature connector. Contacts are medium size, both power and signal currents, solder or crimp	PT, PT-SE, PT-CE, PTS-DR, BP, SP, DC	Solder or crimp, front or rear removal	20, 16, 12	Bayonet thread, version Non-Military	311X solder, 312X crimp F. R. 347X crimp R. R.
MIL-C-22992	Power type connector, heavy duty. MIL-C-5015 insert patterns, rugged. Solder or crimp contacts	QWLD 10-193XXX, Class L 10-473XXX, HK - potted backshell	Solder for MS1734X, Crimp for Military Class "L"	16 thru 0	Threaded (quick thread), double stub	Class L Series is for heavy power. MS9055X Class "L"
MIL-C-83723 *Series I, II & III	Series I mates with MIL-C-26482, 2 Series II mates with MIL-C-5015 Series III mates with MIL-C-26500	Refer to applicable series. BTK, BTW, BTR, BTA, BNK, BYK, BYR, BYW, BYA, BTY, BYY	Crimp, rear removal	20, 16, 12, 8, 0	Threaded and bayonet, depending on series	83723/1 thru 14, 36 thru 49 Series I, 17 thru 27 -29 -30 -33 -34 -35 -50 -52 -53 Series II, 7X -8X -9X Series III
MIL-C-38999	Subminiature - medium and high contact density, crimp contacts. Series I - scoop-proof	Series I, LJT-R, (Also see MIL-C-27599 solder)	Crimp, rear removal	22D, 20, 16, 12, and coax sizes 8, 12, 16	Bayonet	Intermates with Series I of MIL-C-27599
	Series II - lightweight, low profile	Series II, JT-R, (Also see MIL-C-27599 solder)	Crimp, rear removal	22D, 20, 16, 12, and coax sizes 12, 16	Bayonet	Intermates with Series II of MIL-C-27599
	Series III - High performance, but suited for general duty	Series III, TV-R, T3W, T3K, T3F, T3S, T3N, T3Y, Series III CTV - Composite	Crimp, rear removal	22D, 20, 16, 12, and coax sizes 8, 12, 16	Threaded	Available in Class K Firewall and Lanyard Release Breakaway
	Series IV Breech-Lok, expensive design, can be difficult to mate	None	Crimp, rear release	22D, 20, 16, 12, and coax sizes 8, 12, 16	Breech-Lok	Does not meet total performance requirements of Series III
MIL-C-26500	Miniature connector. Contacts are medium size, both power and signal, solder or crimp	ZZW, ZZL, ZZY, ZZB	Crimp, front removal	20, 16, 12	Bayonet and Threaded	Intermates with Series III of MIL-C-83723
MIL-C-81511*	Subminiature - medium and high contact density, crimp contacts. Series I & II - front release contacts Series III & IV - rear release contacts	348 Series	Crimp, front (gang) & rear removal	22, 20, 16, 12	Bayonet	M81511/0X F. R. M81511/4X R. R.
MIL-C-27599	Subminiature, similar to MIL-C-38999 except has non-removable solder contacts. Fully mateable with MIL-C-38999	LJT-T, P - Series I LJT-A, C, P - Series II	Solder	22, 20, 16	Bayonet	Intermates with Series I and II of MIL-C-38999

* Denotes inactive